

Application Stories

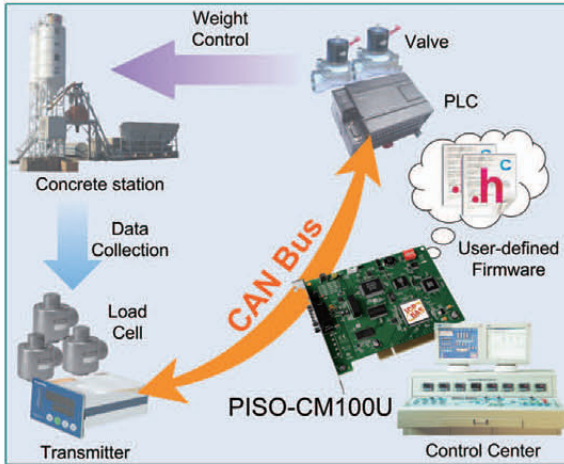

Concrete Station Monitor & Control System

- **Location:** Hunan, China
- **Product:** PISO-CM100U
- **Description:** The result of the quantity control of each recipe material seriously affects the quality of the concrete. In order to adjust each quantities promptly, CAN bus is applied. In this system, the PISO-CM100U is used to monitor the weight of each material from the load cells, and sends the recipe to the PLC. Meanwhile, the PC updates all the data to the screen. By using the user-defined firmware in the CPU of the PISO-CM100U, the PC loading can be effectively reduced, and the system becomes more smooth and reliable.

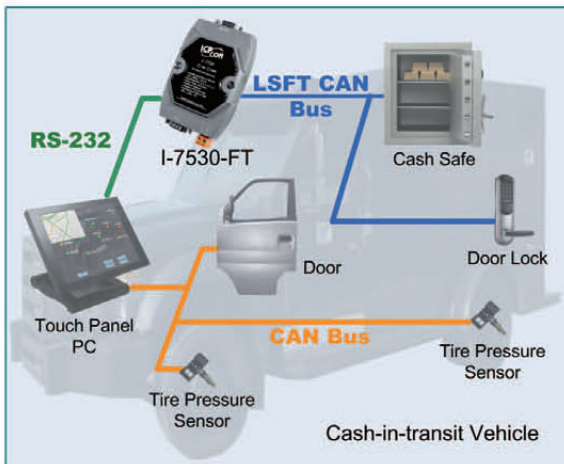

Cash-in-transit Vehicle

- **Location:** England, United Kingdom
- **Product:** I-7530-FT
- **Description:** A telematics and vehicle control system need to be closely integrated with each other by some data-exchange interfaces. LSFT (Low speed fault tolerance) CAN is a kind of familiar interfaces in the autotronics applications. An I-7530-FT is specially designed for solving the interface transformation between LSFT CAN and RS-232. Through it, the cash-in-transit of the manufacturer can control the door of the cash safely and monitor the conditions of the back door directly and reliably on the telematics.

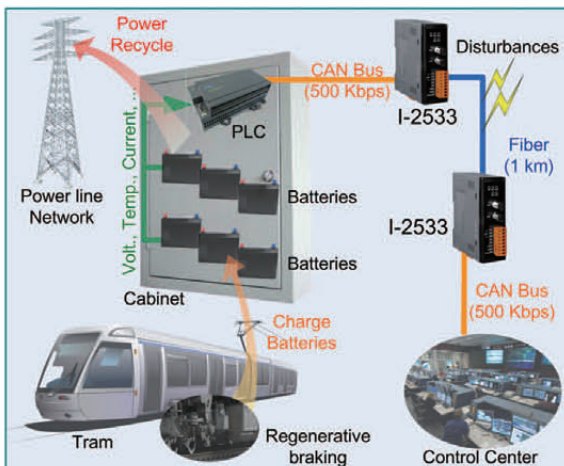

Tram Energy Recycle System

- **Location:** Hyogo, Japan
- **Product:** I-2533
- **Description:** Energy saving and carbon reduction has become what every country has to strive for. Therefore, the customer applies the regenerative braking to recycle the kinetic energy of the tram while it is braking. In order to resistant environment disturbances, extend CAN bus working distance and provide the higher CAN transmission speed, a couple of I-2533s are used. By means of them, the transmission distance of CAN bus is extended via 1 km fiber optics while using 500 kbps CAN baud rate.

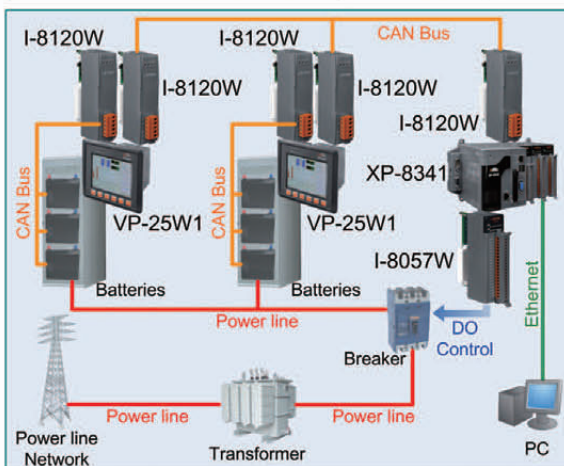

Energy Storage System

- **Location:** Guangdong, China
- **Product:** I-8120W, I-8057W, VP-25W1, XP-8341
- **Description:** This system can improve the usage efficiency of the electrical power. During the off-peak time of the electricity use, the unused electricity can be stored in the battery. When the peak time is coming, these batteries supply the power to the electric grid. The customer utilizes one of the I-8120Ws in VP-25W1 to monitor the battery status, and another is used to feedback these data to the XP-8341. The XP-8341 transmits the status to the PC via Ethernet and control the charge time by the breaker.

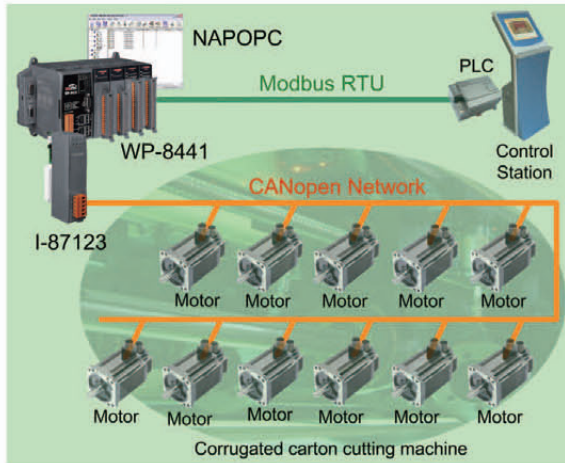

Corrugated Carton Cutting Machine

- **Location:** Taichung, Taiwan
- **Product:** WP-8441, I-87123
- **Description:** In this case, the orientation and cutting speeds seriously affect the quantity of output. Because all of the cutting knives and rollers must be controlled by 31 motors, the customer selects the CANopen motors to do that. The WP-8441 and I-87123 play the role of a CANopen master to control all of the motors simultaneously by the CANopen features of the synchronization and high speed. By using this architecture, all of the motors can quickly move to the target position at the same time by just sending one command.

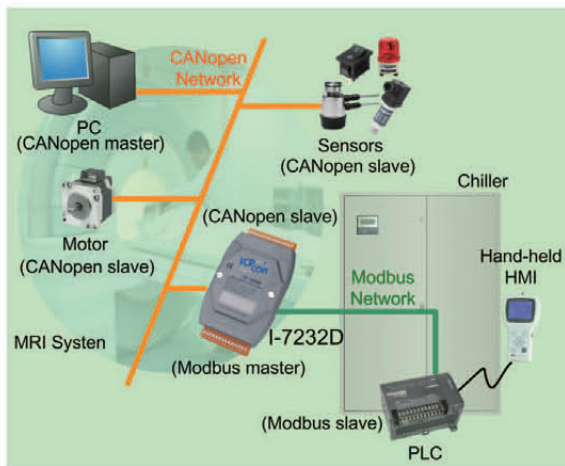

MRI Cooling System

- **Location:** Guangdong, China
- **Product:** I-7232D
- **Description:** In order to reduce the cost, a MRI manufacturer use the chiller made in China instead of German product. However, the customer gets into trouble with the different communication interface. By using the I-7232D, this problem is solved. I-7232D can be the Modbus RTU master while talking with the chiller. In the CANopen network, I-7232D is a CANopen slave. Therefore, I-7232D can easy bypass the information of the chiller to the CANopen master, and transfer the CANopen commands to the chiller.

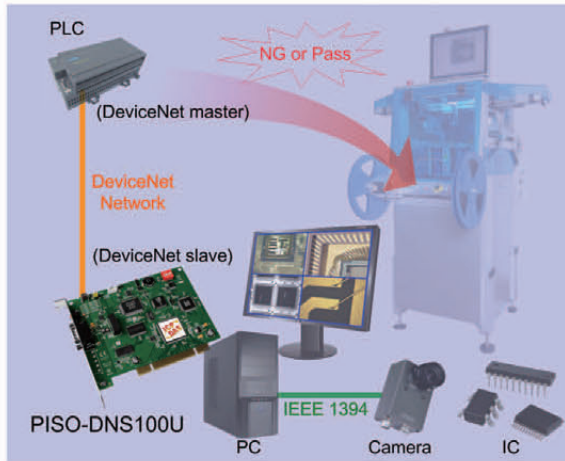

IC Inspection Machine

- **Location:** Hsinchu, Taiwan
- **Product:** PISO-DNS100U
- **Description:** The IC inspection process is necessary for a good quality control. Though the PLC is cheap and stable, the IC inspection is a tough work for a PLC. The customer uses PC+ camera + PISO-DNS100U to do the IC inspection, and uses PLC to control the mechanism for rejecting the defective ICs. After finishing the inspection, the PC writes the result to the PISO-DNS100U. Because the PLC is a DeviceNet master, it can easily get the information from the PISO-DNS100U via DeviceNet network.

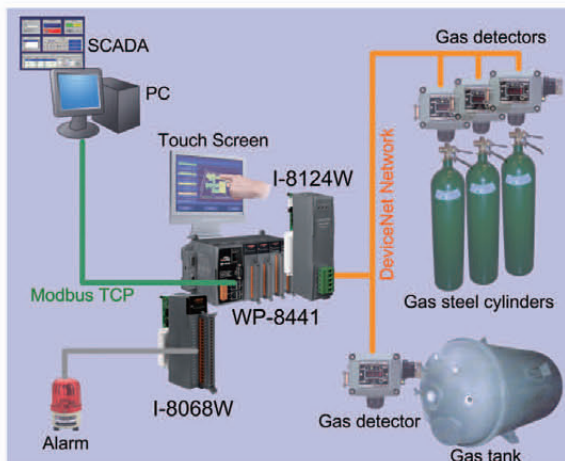

Semiconductor Gas Detection System

- **Location:** Kaohsiung, Taiwan
- **Product:** WP-8441, I-8124W
- **Description:** In semiconductor factory, a lot of poison and inflammable gas are widely used in various processes. In order to keep the employees safe, the gas detectors are general applied to detect the concentration of the poison and inflammable gas in the semiconductor. The customer uses WP-8441+I-8124W to be the DeviceNet master for obtaining the concentration information from the gas detectors. Besides, the present employees can immediately understand the air quality via the touch screen of the WP-8441.